



The Ayrton DIABLO is a high-performance lighting fixture designed for professional lighting applications. It's a 300W profile luminaire that belongs to the Mistral series, known for its compact size and versatility.

**A**YRTON's latest innovation, DIABLO TC, is a versatile, feature-rich 300 W profile luminaire based on the ultra-compact MISTRAL format. The company has taken on the ambitious challenge of making DIABLO TC the smallest, lightest and most efficient luminaire of its category. With a record output of 11,000 lumens and a total weight of 22 kg, DIABLO S is a powerhouse of technology that will tempt the most demanding lighting designers.

## ★ KEY FEATURES

### ➤ Output

The DIABLO boasts an impressive output of 19,000 lumens. This level of brightness makes it suitable for various lighting design applications, including stage productions, concerts, and architectural lighting.

### ➤ Weight

Despite its high output, Ayrton has managed to keep the DIABLO's weight relatively low at 22 kg. This makes it easier to handle and install, especially in situations where weight constraints are a concern.

### ➤ Technology

The DIABLO is a "powerhouse of technology", it incorporates advanced lighting and control technologies to deliver outstanding performance.

### ➤ Versatility

DIABLO can be used to create focused and controllable beams of light. This makes it suitable for tasks such as spotlighting performers, highlighting specific architectural elements, or adding dramatic effects to a stage or event.

### ➤ Colour Precision

Ayrton's objective to maximize efficiency suggests that the DIABLO is designed to deliver a high level of brightness while minimizing power consumption. This is important for both energy savings and reducing heat output.

### ➤ Framing System

Ayrton has miniaturized the framing system. DIABLO offers precise control over the shape and position of the light beam, allowing lighting designers to create intricate and dynamic effects.

TECHNICAL SPECIFICATIONS

SOURCE	
Engine	LED Mono Block Sealed White
LED Watts	300 W (total fixture use see Electrical section)
LED Engine Life (L70)	Up to 40,000 Hours
LED Refresh Rate	1.2 KHz, 2.4 KHz, 16 KHz
Dimming	Electronic
Dimming Curves	Square & Linear
Dimming Control Options	Auto on/off dimmer smoothing when Snap effects
Strobe Speed	Hz 1-25 Per Second
Strobe Modes	Strobe Effects / Pulse Effects / Random Effects

ELECTRICAL	
Max Power Consumption	550 W
Standby Consumption	85 W @ 20°C
Voltage Range	100-240 V 50-60 Hz
Current (Max)	2.4 A @ 230 V / 5 A @ 110 V
Inrush (Half Cycle)	110 V: 10.1 A 230 V: 8.9 A
Total Fixtures per Circuit	6 @ 220/230 V 4 @ 110 V
Connector	True1 Compatible In/Thru
Power Supply Unit	Active PFC
Contains Battery	Li-ion 3.7V Rechargeable

TYPICAL POWER AND CURRENT	
120V , 60Hz	4.18 A, 501.7 W, PF 0,993
208V, 60Hz	2.38 A, 495 W,PF 0.978
230V, 50Hz	2.13 A, 490.8 W, PF 0.970
240V, 50Hz	2.11 A, 506.4 W, PF 0.970

Suitable disclaimer nominal, etc

OPTICAL PERFORMANCE	
Lens Size	119 mm (4.7 in)
Zoom Range	7° to 53°
Zoom Ratio	7.5 : 1
Gate Size	20 mm (0.79 in)

MOVEMENT		
Pan Range	540°/630° (optional)	
Pan Speed (End to End or range)	180°	40 rpm
	360°	40 rpm
	EtoE	40 rpm
Tilt Range	263°	
Tilt Speed (End to End or range)	180°	43 rpm
	EtoE	47 rpm
Resolution	8- or 16-bit	
Calibration Time	43 seconds	
Position Correction System	Yes / Automatic repositioning	
Follow Spot Modes	Tracking system	

COLOUR SYSTEM	
Colour System(s)	CMY, CTO and 7 Colour Wheel
Control	CMY 16-Bit & 8-Bit
CTO	Variable
Variable CTP	No
Colour Wheel	One Wheel. Seven Dichroic plus one open changeable colour (see chart for standard)
Colour Wheel Effects	Continuous Rotation

GOBOS	
Indexing Wheel	1
Indexing Gobos	7 (Glass see load below) + 1 Open
Gobo Diameter (Index)	25.5 mm
Image Diameter (Index)	20 mm
Static Wheel	No
Static Gobos	No
Gobo Diameter (Fix)	N/A
Image Diameter (Fix)	N/A
Gobo Thickness	1.1 to 2.2 mm
Animation Wheel	Yes
Animation Details	Bi-Directional with continuous rotation

TECHNICAL SPECIFICATIONS

PERFORMANCE		
Output Goniometer Lumens		11,203
Engine Lumens		20,500
Field Lumens	Narrow	6,723 lm <sup>1</sup>
	Middle	11,203 lm <sup>1</sup>
	Wide	11,341 lm <sup>1</sup>
Integrated Sphere Lumens		13,888 (Fan Mode Auto after derating)
Lumen Per Watt (LPW)		22.6
CCT		6,500 K
Ra @ Open		90 (±2)
CRI		> 90
Tm30		Rf: 87.1 Rg: 93.8
TLCI		90
CQS		88.2

1. Goniometer lumens

IMAGING	
Framing	4 Blade – 4 Plain
Framing Rotation	+/- 45°
Iris	15 Leaf - 5% to 100% (Open)
Frost	Linear Light (Heavy optional, included)
Prism	5-Facet Circular Indexable & Rotating

CONNECTORS	
Power	In/ Thru powerCON True 1
DMX	In/Thru 5 Pin XLR
Network	No
Wireless	DMX Only

CONTROL	
DMX Control	DMX (USITT DMX-512-A) RDM (ANSI/ESTA E1.20)
Transceiver/Receiver	RS-485 with Isolation
DMX Modes	3 + 3 User Modes
Channel Count	Mode 1 Standard – 36 Mode 2 Basic – 34 Mode 3 Extended – 56
DMX Chart	Scan the QR code on page 5
Network Protocols	None
Local Control	Colour LCD Panel Clicking Jog Wheel
Stand Alone Mode	Master/Slave, presets 250
RDM Functions	Yes
Wireless DMX	CRMX TiMo RDM receiver
E-Sim Ready	No
USB Port	No

THERMAL	
Max Surface Temperature, steady state, at Ta 40°	85°C (185°F)
Max Ambient Temperature (Ta Max)	43°C (113°F)
Min Ambient Temperature (Ta Min)	-10°C (14°F)
Total Heat Dissipation (Calculated +/- 10%)	146.5 BTUs p/h 500 W @ 230 V
Minimum distance to illuminated surface	1.5m (4.91ft)
Minimum distance to combustible surface	3 m (9.84 ft)
Thermal Protection system	Yes
Cooling modes	See Acoustics
Cooling System	Advanced Liquid Cooling

TECHNICAL SPECIFICATIONS

ACOUSTICS STATIC		
Fan Mode	dBA <sup>2</sup>	NC <sup>3</sup>
Auto	40.5	32
Stage	41.6	30
Silence/Studio	28.9	17
Super Silence	28.3	18

DYNAMIC		
Mode	dBA <sup>2</sup>	NC <sup>3</sup>
Auto	43.6	32
Stage	45.4	34
Silence/Studio	41.8	32
Super Silence	42.2	33

2. Measured @ 1m Static, 31dBA ambient  
 3. Noise Criterion  
[https://www.engineeringtoolbox.com/nc-noise-criterion-d\\_517.html](https://www.engineeringtoolbox.com/nc-noise-criterion-d_517.html)

ENVIRONMENTAL	
IP Rating	IP 20
Salt Spray Testing	N/A
Estimated embodied carbon	228.4 kg CO <sub>2</sub> e
Recycling options	Packaging fully recycled and widely recyclable
SIP Optional	Yes

**EOL Policy**

WARRANTY	
Fixture	2 years
LED Engine	5 years

From date of invoice

INSTALLATION	
Orientation	Any
Mounting attachments	<ul style="list-style-type: none"> <li>Fastening-bracket system: two Omega ¼ turn brackets designed for use with standard clamps</li> <li>Mounting points: four ¼ turn locking fittings allowing installation of Omega brackets on luminaire</li> <li>Safety-cable attachment point</li> </ul>
Installation version	Yes, Fixed Tails

CONSTRUCTION	
Colour	Black Standard Custom colours on request
Housing	ABS PC (VO class)
Materials	<ul style="list-style-type: none"> <li>Moving-head skeleton made of aluminium and steel metal plates.</li> <li>Base in die-cast aluminium.</li> <li>Aluminium and copper heatsinks.</li> </ul>

INCLUDED ITEMS	
Manual	1
OMEGA brackets with quarter-turn locks	2
Cables	1.5 m powerCON True1 TOP Tails Bared
Other accessories	Gobo's x4 Additional Heavy Frost Option

TECHNICAL SPECIFICATIONS

PHYSICAL	
<b>Fixture</b>	
Length	365 mm (14.3 in)
Height	591 mm (23.3 in)
Depth	212 mm (8.4 in)
Weight	22 kg (48.5 lb)
<b>Shipping Dimensions</b>	
Length	445 mm (17,52 in)
Height	750 mm (29.5 in)
Depth	295 mm (11.6 in)
Weight	30.5 Kg (68 lb)
<b>In SIP Dimensions</b>	
Length	430 mm (14.4 in)
Height	660 mm (25.9 in)
Depth	280 mm (11 in)
Weight (excl fixture)	8 kg (17,6 lb)

SUPPORTING DOCUMENTS	
<a href="#">Manual</a>	
<a href="#">GDTF Profile</a>	
<a href="#">GMA Profile</a>	
<a href="#">IES File</a>	
<a href="#">DMX Tables</a>	
<a href="#">Photometric Files</a>	
<a href="#">Software</a>	
<a href="#">Warranty</a>	

COMPLIANCE	
<b>EU (EMC &amp; LVD)</b>	<ul style="list-style-type: none"> <li>• EMC Directive 2014/30/EU</li> <li>• LVD Directive 2014/35/EU</li> </ul>
<b>US (Safety &amp; EMC)</b>	<ul style="list-style-type: none"> <li>• UL 1573</li> <li>• FCC Part 15, Subpart B: 2018</li> </ul>
<b>ROHS Compliant</b>	Yes
<b>Declarations</b>	Scan the QR code above

ORDERING DETAILS	
<b>Diablo S</b>	011340

ACCESORIES	
<b>Lynx Control</b>	045130

TECHNICAL SPECIFICATIONS

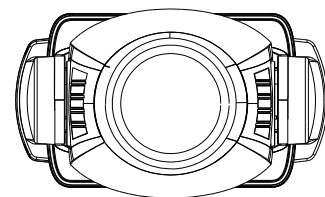
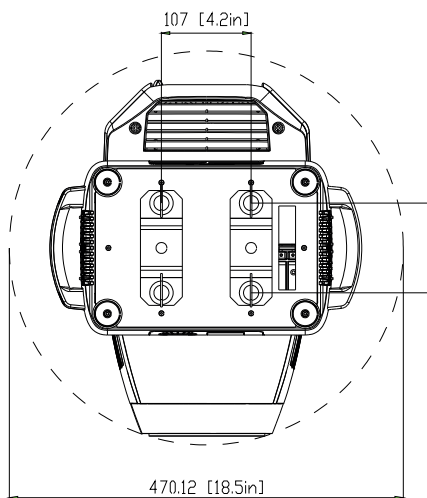
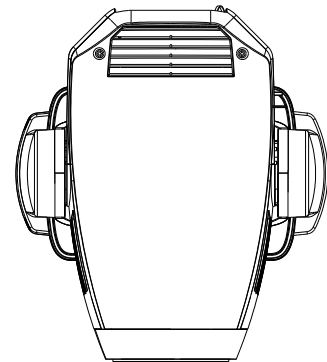
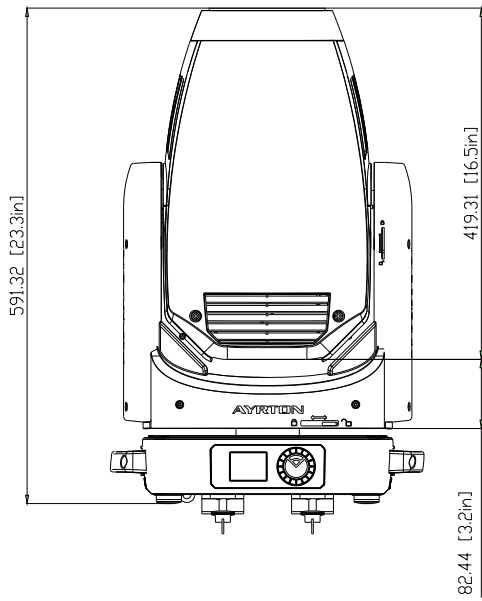
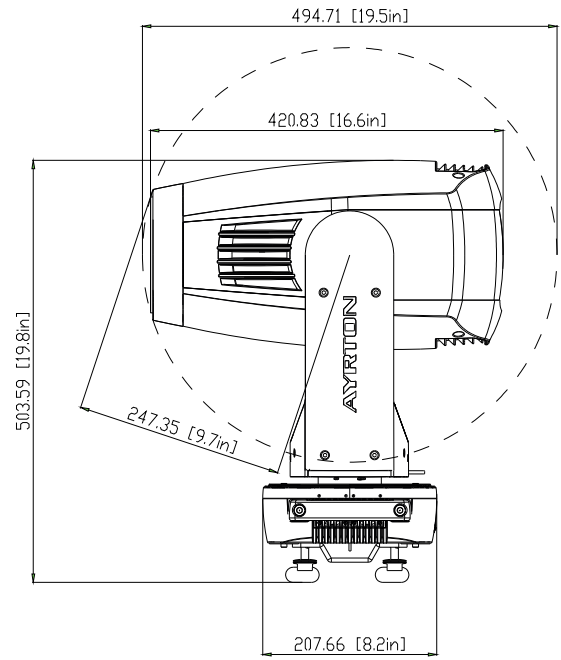
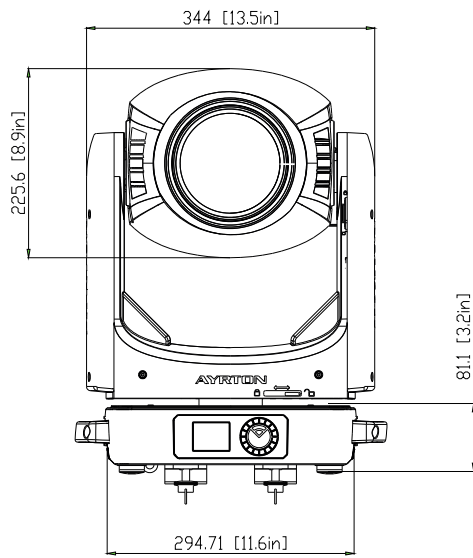

TECHNICAL SPECIFICATIONS

> Dimension/Tolerance/Requirement:

Black & White Gobo:

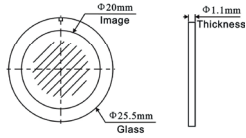

Color Gobo:

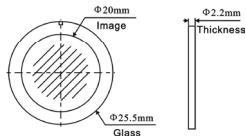

> Color Filter Dimension:

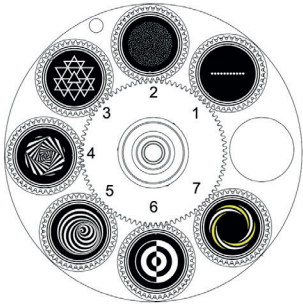
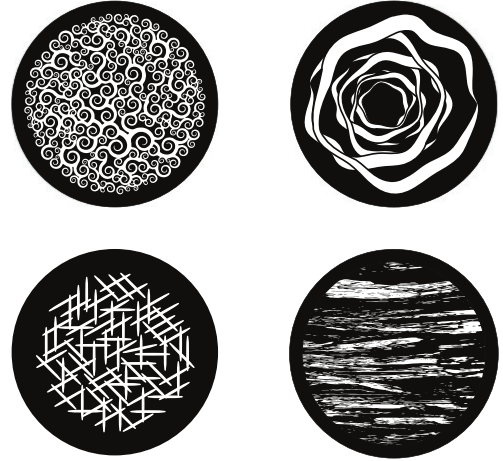
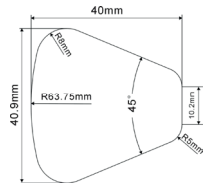

GOBO WHEEL

Rotating Gobo

1	130	Dot Line 11	GP60303010903
2	074	Star Dust	GP60303010906
3	018	Nested Triangle	GP60303010905
4	039	Infinite Stairs	GP60303010867
5	134	Vortex	GP60303010904
6	067	Black & White Target	GP60303010926
7	112Y	Nested Rings Yellow	GP60303060055

This side facing LED module

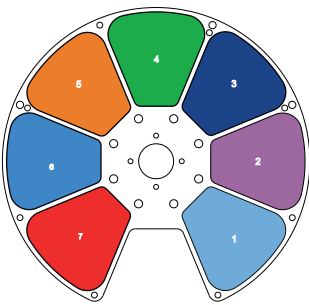

COLOR WHEEL

Animation Wheel

1	CTB 1/4	GP60305032892
2	Magenta	GP60305032893
3	Congo Blue	GP60305032894
4	Green	GP60305032895
5	Orange	GP60305032896
6	Blue	GP60305032897
7	Red	GP60305032898

This side facing LED module

ADDITIONAL GOBOS FOR DIABLO

Included in the package

1	041	Lost In The Brain	GP60303010911
2	049	Smoke Rings	GP60303010909
3	081	Iron Filings	GP60303010932
4	105	Tree Bark	GP60303010915

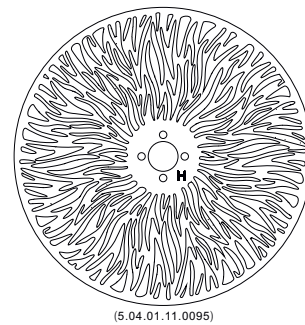

(5.04.01.11.0095)

AUTO MODE: PHOTOMETRIC DETAIL

MIN ZOOM

BEAM OPENING

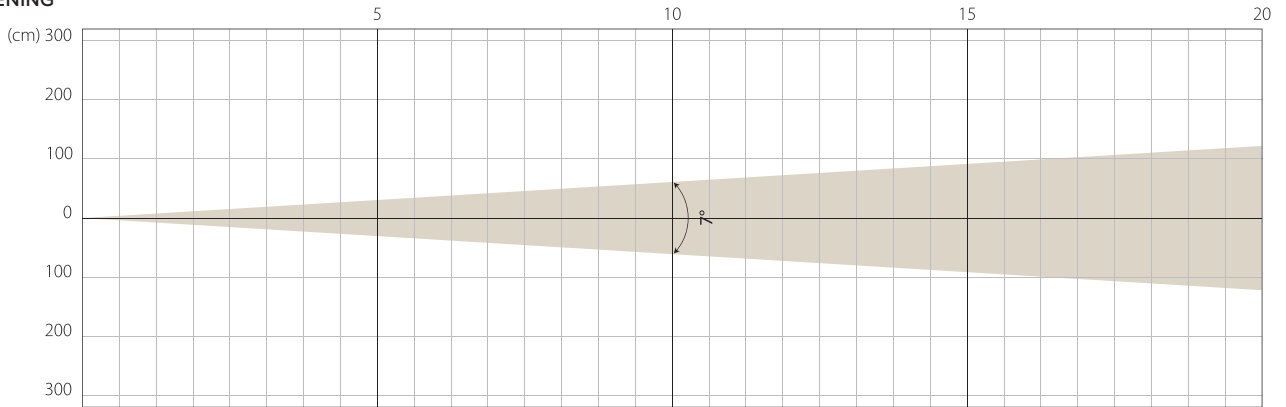

INTENSITY

Distance (m)	5		10		15		20	
	Lux	Diameter	Lux	Diameter	Lux	Diameter	Lux	Diameter
White	24854	0,61	6213	1,22	2762	1,83	1553	2,45

MIDDLE ZOOM

BEAM OPENING

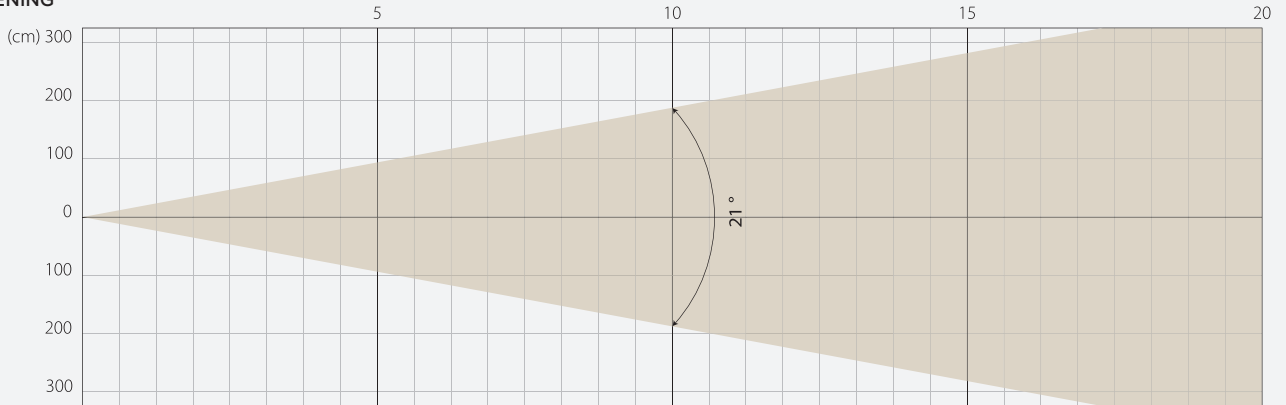

INTENSITY

Distance (m)	5		10		15		20	
	Lux	Diameter	Lux	Diameter	Lux	Diameter	Lux	Diameter
White	5202	1,85	1300	3,71	578	5,56	325	7,41

MAX ZOOM

BEAM OPENING

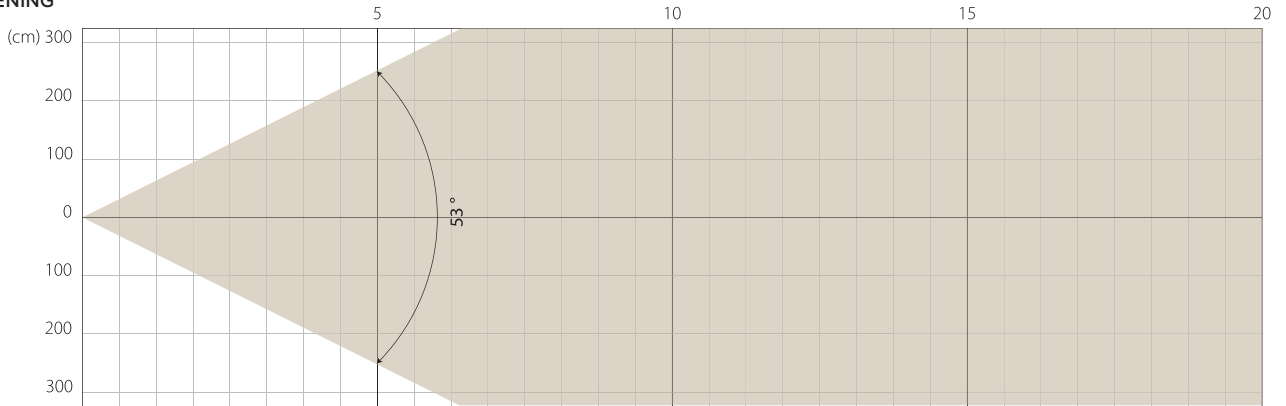

INTENSITY

Distance (m)	5		10		15		20	
	Lux	Diameter	Lux	Diameter	Lux	Diameter	Lux	Diameter
White	940	4,99	235	9,97	104	14,96	59	19,94



STAGE MODE: PHOTOMETRIC DETAIL

MIN ZOOM

BEAM OPENING

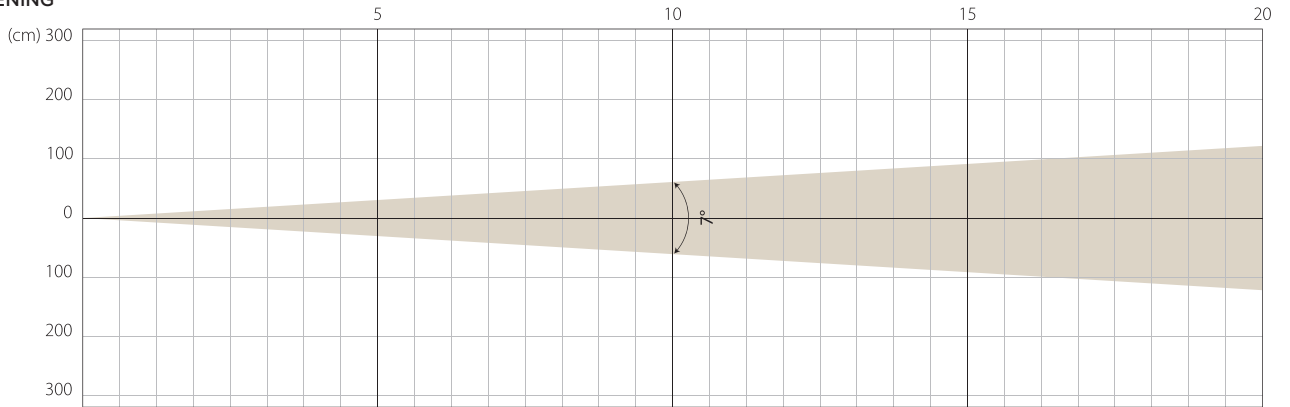

INTENSITY

Distance (m)	5		10		15		20	
	Lux	Diameter	Lux	Diameter	Lux	Diameter	Lux	Diameter
White	25441	0,61	6360	1,22	2827	1,83	1590	2,45

MIDDLE ZOOM

BEAM OPENING

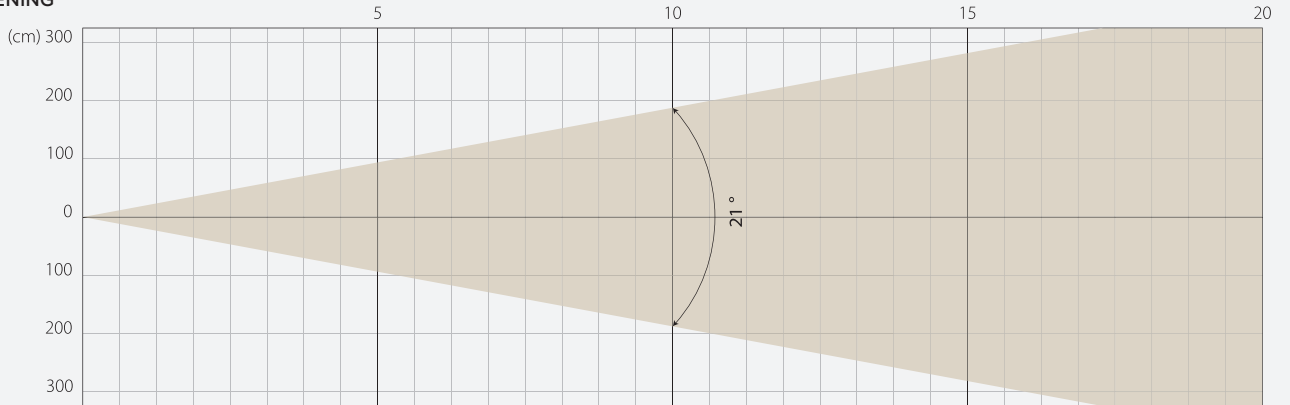

INTENSITY

Distance (m)	5		10		15		20	
	Lux	Diameter	Lux	Diameter	Lux	Diameter	Lux	Diameter
White	5247	1,85	1312	3,71	583	5,56	328	7,41

MAX ZOOM

BEAM OPENING

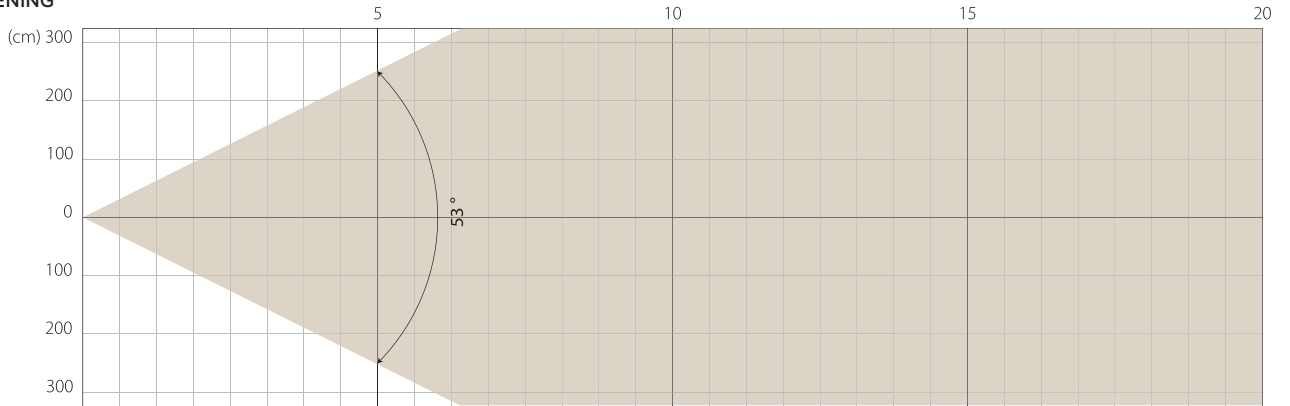

INTENSITY

Distance (m)	5		10		15		20	
	Lux	Diameter	Lux	Diameter	Lux	Diameter	Lux	Diameter
White	953	4,99	238	9,97	106	14,96	60	19,94

SILENCE MODE: PHOTOMETRIC DETAIL

MIN ZOOM

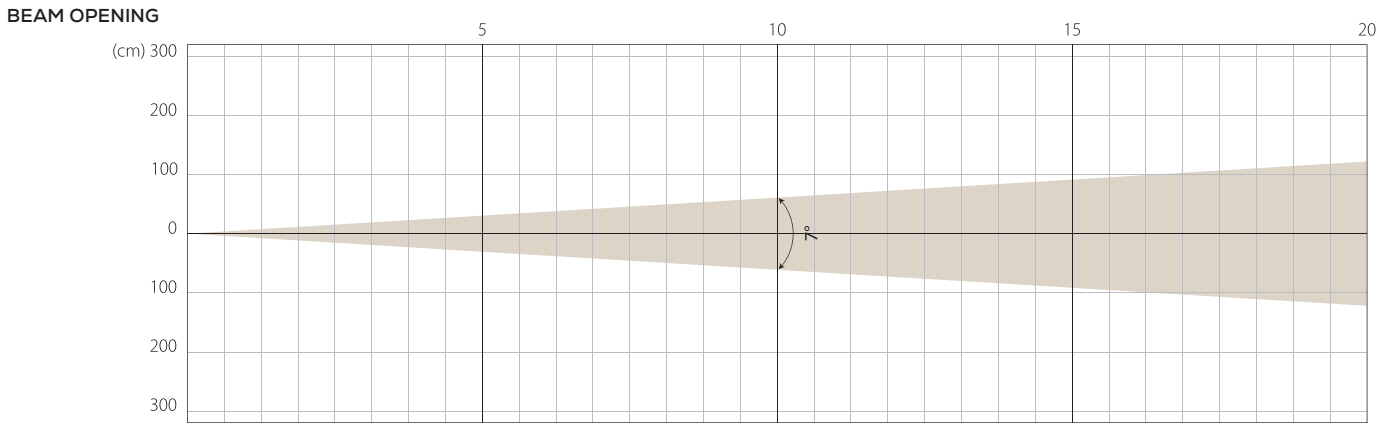

INTENSITY

Distance (m)	5		10		15		20	
	Lux	Diameter	Lux	Diameter	Lux	Diameter	Lux	Diameter
White	16037	0,61	4009	1,22	1782	1,83	1002	2,45

MIDDLE ZOOM

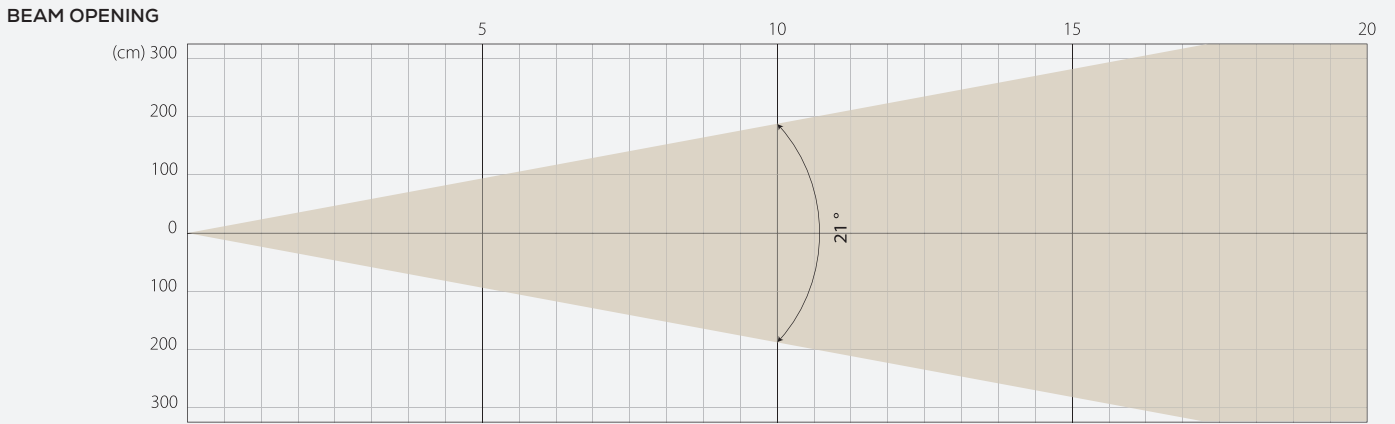

INTENSITY

Distance (m)	5		10		15		20	
	Lux	Diameter	Lux	Diameter	Lux	Diameter	Lux	Diameter
White	3377	1,85	844	3,71	375	5,56	211	7,41

MAX ZOOM

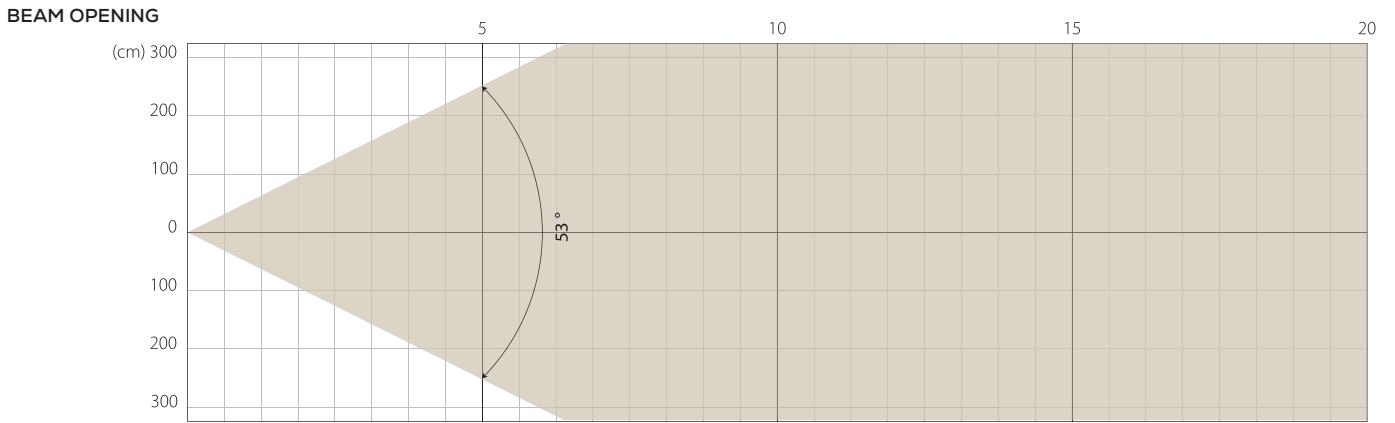

INTENSITY

Distance (m)	5		10		15		20	
	Lux	Diameter	Lux	Diameter	Lux	Diameter	Lux	Diameter
White	607	4,99	152	9,97	67	14,96	52	19,94

SUPER SILENCE MODE: PHOTOMETRIC DETAIL

MIN ZOOM

BEAM OPENING

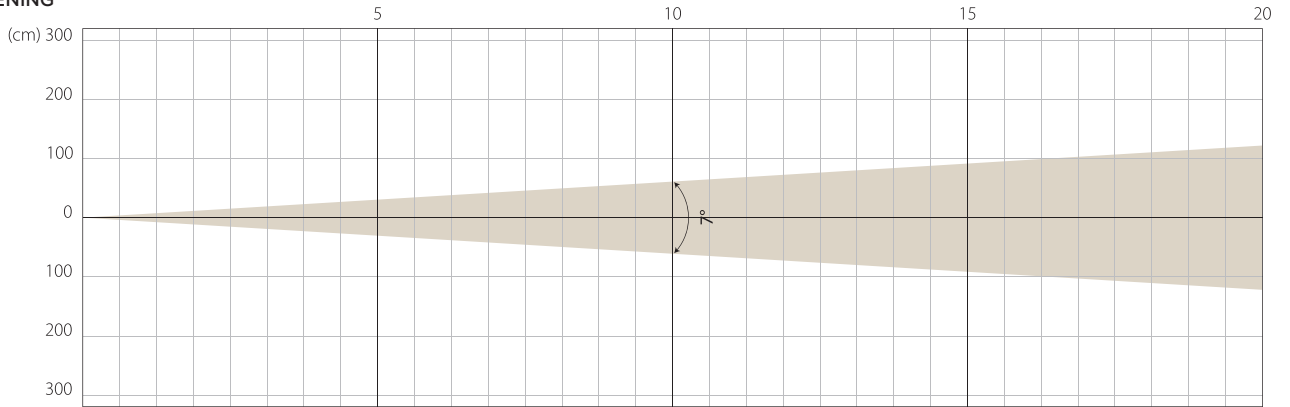

INTENSITY

Distance (m)	5		10		15		20	
	Lux	Diameter	Lux	Diameter	Lux	Diameter	Lux	Diameter
White	14689	0,61	3672	1,22	1632	1,83	918	2,45

MIDDLE ZOOM

BEAM OPENING

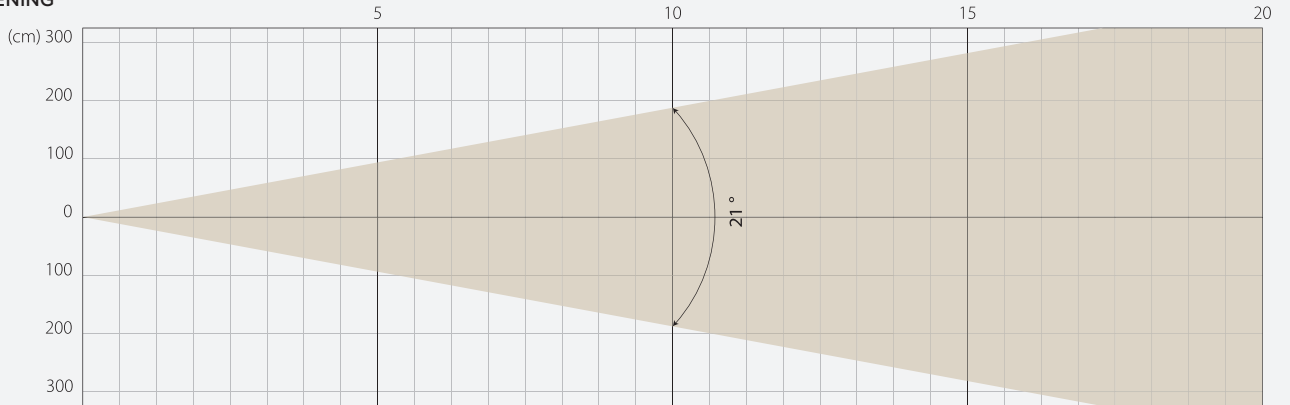

INTENSITY

Distance (m)	5		10		15		20	
	Lux	Diameter	Lux	Diameter	Lux	Diameter	Lux	Diameter
White	3072	1,85	768	3,71	341	5,56	192	7,41

MAX ZOOM

BEAM OPENING

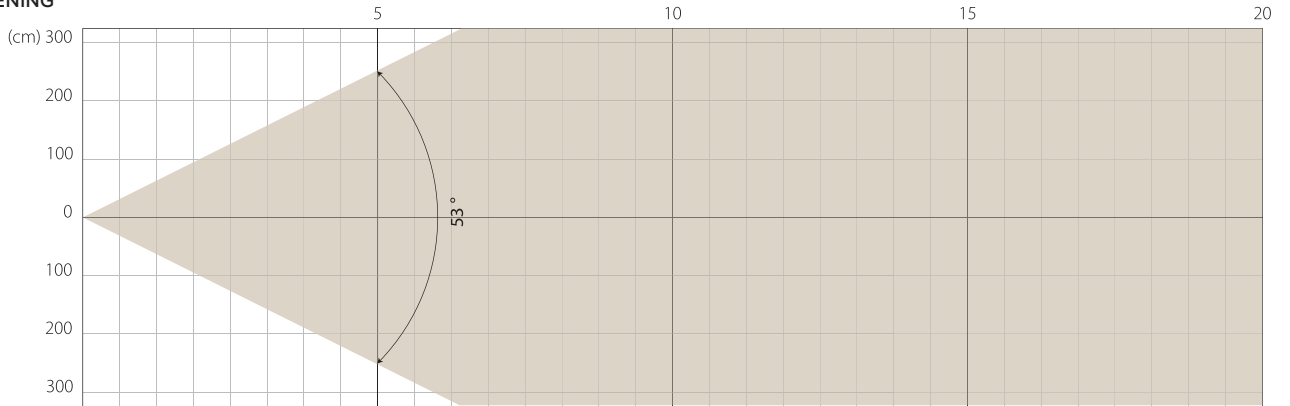

INTENSITY

Distance (m)	5		10		15		20	
	Lux	Diameter	Lux	Diameter	Lux	Diameter	Lux	Diameter
White	555	4,99	139	9,97	62	14,96	35	19,94

COLOR PARAMETERS

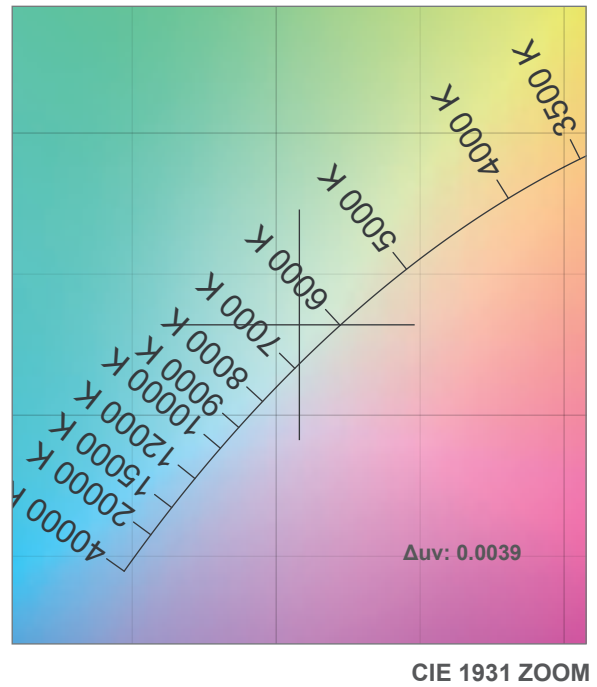
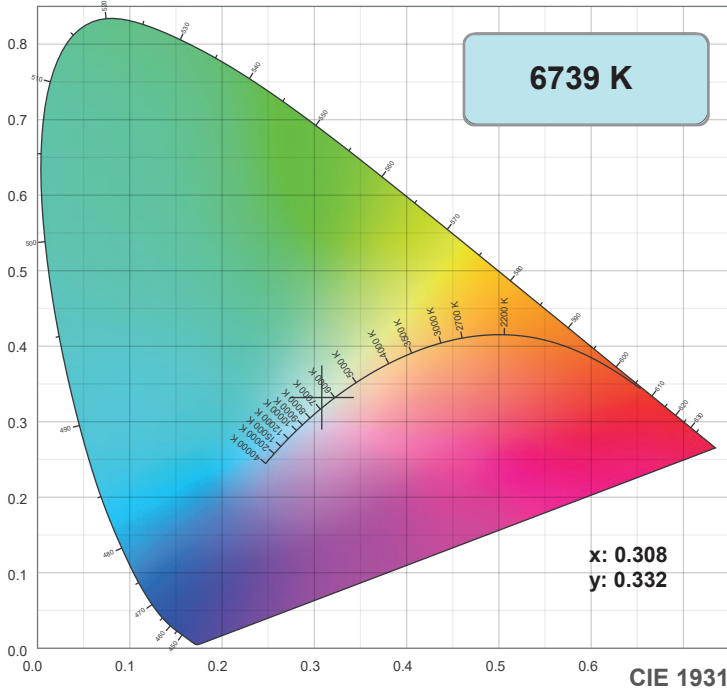

TM-30: 87.1

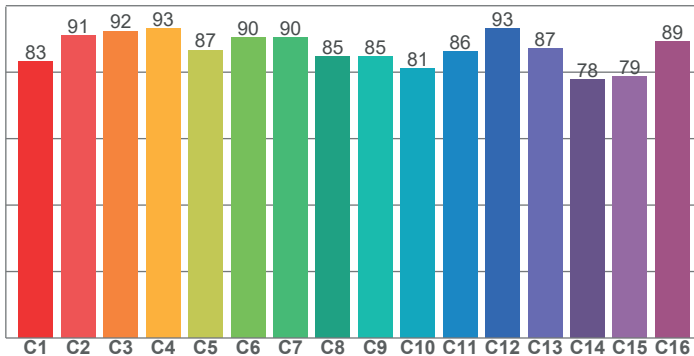

CRI: 89.6 (R1-R8)

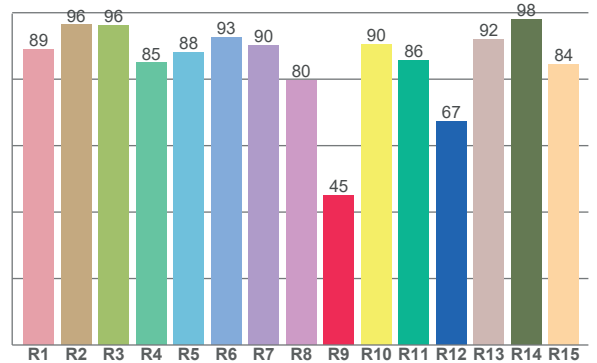

CQS: 88.2

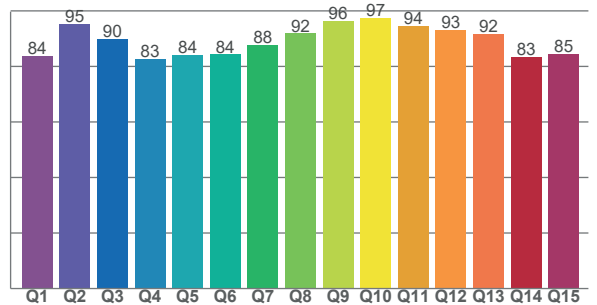

CRI R values, only R1-R8 are used to calculate final CRI value

R1	R2	R3	R4	R5	R6	R7	R8	R9	R10	R11	R12	R13	R14	R15
89.0	96.3	96.1	84.9	87.9	92.6	90.1	79.6	45.0	90.4	85.8	67.1	91.8	98.0	84.4

TM30 C values, 16 binned values out of total of 99 C values

C1	C2	C3	C4	C5	C6	C7	C8	C9	C10	C11	C12	C13	C14	C15	C16
83.2	91.0	92.4	93.2	86.7	90.5	90.4	84.8	84.7	81.1	86.1	93.2	87.1	77.8	78.7	89.1

CQS Q values

Q1	Q2	Q3	Q4	Q5	Q6	Q7	Q8	Q9	Q10	Q11	Q12	Q13	Q14	Q15
83.8	95.2	89.9	82.8	84.1	84.3	87.8	91.9	96.5	97.5	94.5	93.2	91.8	83.5	84.6

Color parameters

Color temperature	Color rendering index	Red component	Color fidelity	Color gamut	Color quality scale	Color coordinate cie 1931	Color coordinate cie 1931	Color coordinate	Color coordinate	Color deviation from black body
CCT	CRI	CRI R9	TM30 Rf	TM30 Rg	CQS	x	y	u	v	$\Delta uv$
6739 K	89.6	45.0	87.1	93.8	88.2	0.308	0.332	0.193	0.313	0.0039

TM-30







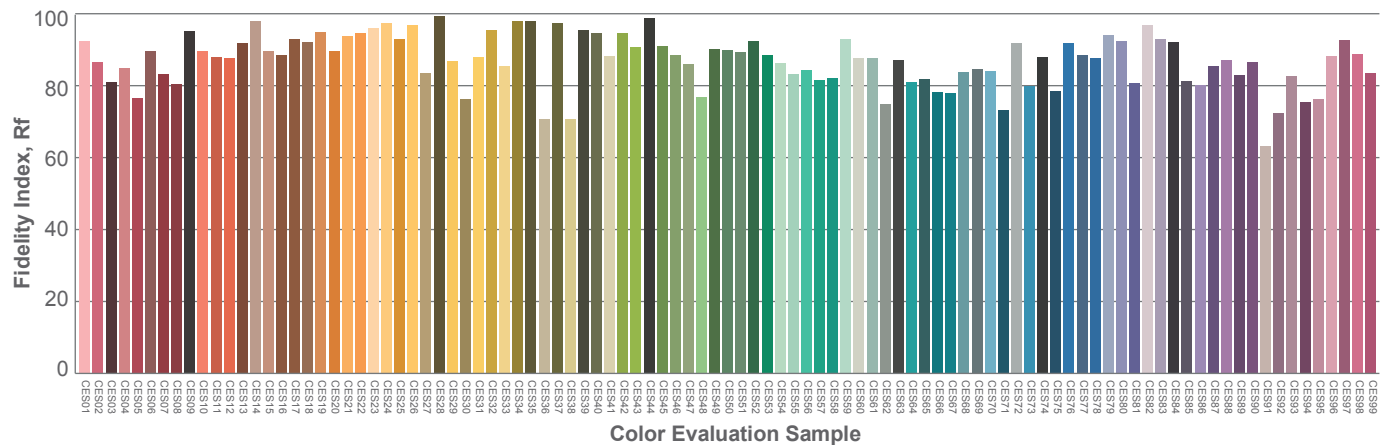
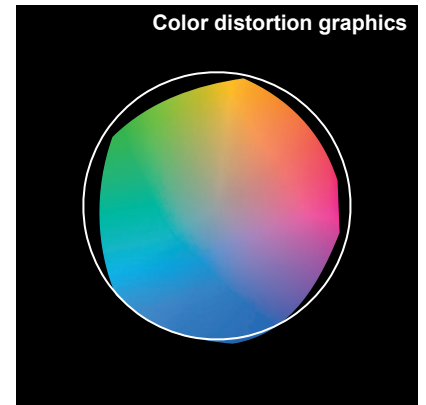
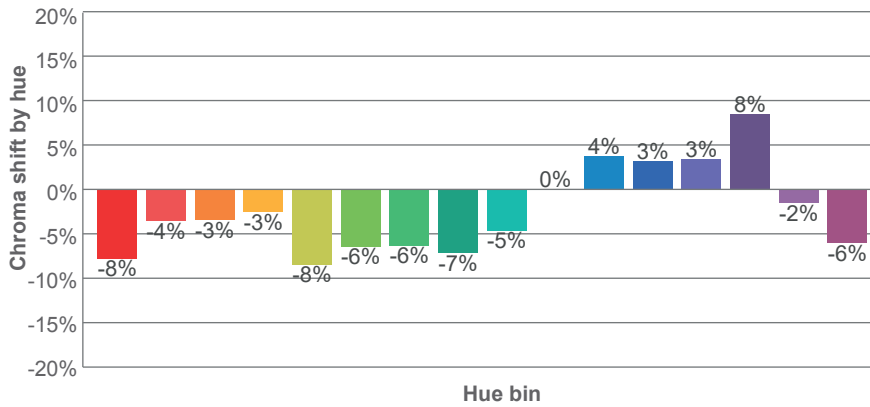
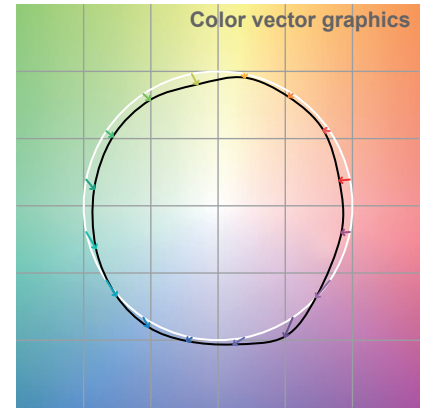
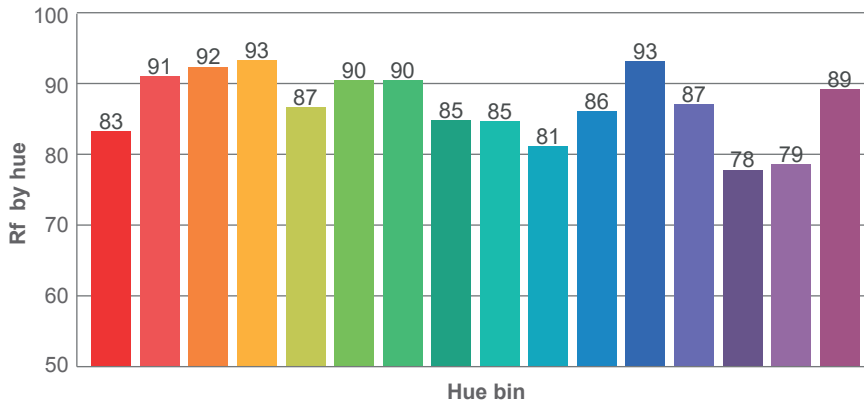
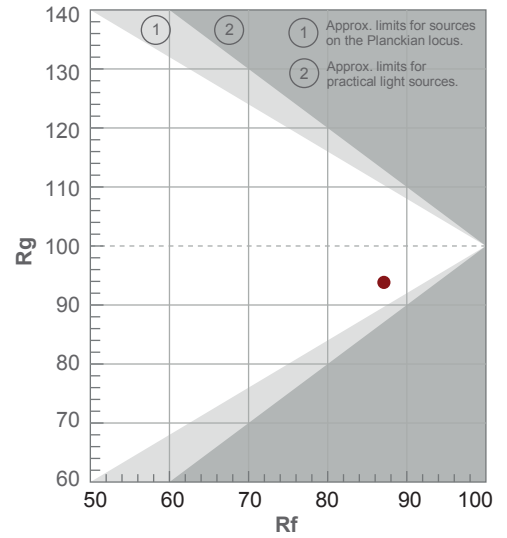







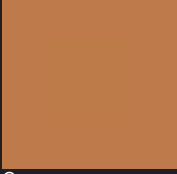

**Rf 87.1**  
Fidelity index Rf

**Rg 93.8**  
Gamut index Rg

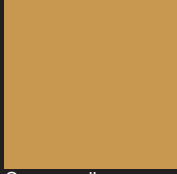
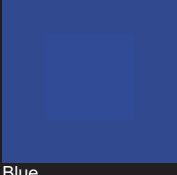
Hue Bin	R <sub>f</sub>	Shifts (%)	
		Chroma	Hue
1	83	-8%	1%
2	91	-4%	3%
3	92	-3%	1%
4	93	-3%	-1%
5	87	-8%	-3%
6	90	-6%	-2%
7	90	-6%	1%
8	85	-7%	6%
9	85	-5%	13%
10	81	0%	14%
11	86	4%	7%
12	93	3%	-3%
13	87	3%	-9%
14	78	8%	-13%
15	79	-2%	-16%
16	89	-6%	-2%

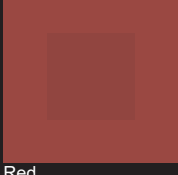

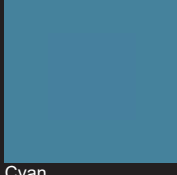
TLCI-90

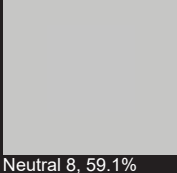
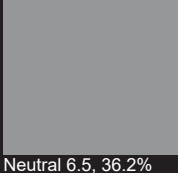
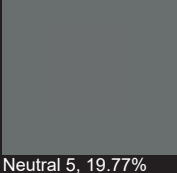
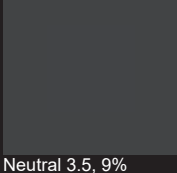
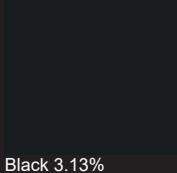
					
Dark skin	Light skin	Blue sky	Foliage	Blue flower	Bluis green
					
Orange	Purplish blue	Moderate red	Purple	Yellow green	Orange yellow
					
Blue	Green	Red	Yellow	Magenta	Cyan
					
White 90.01%	Neutral 8, 59.1%	Neutral 6.5, 36.2%	Neutral 5, 19.77%	Neutral 3.5, 9%	Black 3.13%

 **DISCLAIMER**

*The information provided in this data sheet is for general informational purposes only. While we endeavour to ensure accuracy and reliability, we make no representations or warranties, express or implied, about the completeness, accuracy, reliability, suitability, or availability of the data sheet or its contents. We expressly disclaim liability for errors, omissions, or inaccuracies in the content. Users are responsible for verifying the accuracy and suitability of the information for their specific purposes. Any reliance on this information is strictly at your own risk. Ayrton shall not be liable for any loss or damage arising from the use of this data sheet, including indirect or consequential loss or damage, or loss of data or profits. Links to other websites are provided for convenience and do not imply endorsement. We strive to maintain smooth operation, but we are not liable for temporary unavailability due to technical issues beyond our control.*